

LIFT-RITE®

USER MANUAL

MODEL LFTSC 2.0

Serial Number: 22491313.245201 and Up

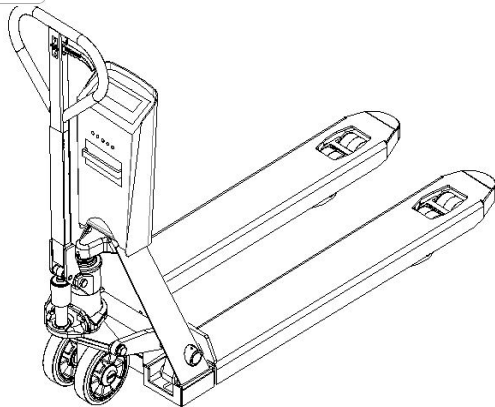
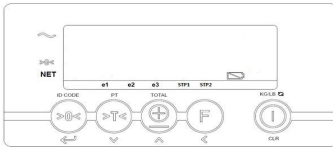

We would like to inform you about the fact that this Lift-Rite product is 100% recyclable on the basis that the parts are processed and disposed of in the right manner.

Published: 2024-12-06
Printing/Typographical errors and model changes reserved.

PLEASE RETAIN THESE INSTRUCTIONS FOR FUTURE REFERENCE

If you have any queries concerning the duration and terms of the guarantee, please contact your supplier. We would also refer you to our General Sale and Supply Conditions, which are available on request.

The manufacturer accepts no liability for any damage or injury caused by failure to follow these instructions, or from negligent operation or assembly, even if this is not expressly stated in this instruction manual.

In light of our policy of continuous improvement, it is possible that details of the product may differ from those described in this manual. For this reason, these instructions should only be treated as guidelines for the installation of the relevant product. This manual has been compiled with all due care, but the manufacturer cannot be held responsible for any consequences of errors. All rights are reserved and no part of this manual may be reproduced in any way.

Table of Contents

1. Introduction	4
2. Warning & Safety measures	4
2.1 Lithium-ion Battery (option)	5
3. System setup	7
3.1 Placing the battery pack in the pallet truck	7
3.2 Switching on/off	8
4. Changing battery	8
4.1 Low battery indication	8
4.2 Charging the battery pack of the pallet truck	9
5. Use	10
5.1 Use (accurate weighing)	10
5.2 Auto shut-off indicator	12
5.3 Indicator functions	13
5.4 Error messages	15
5.5 Net / Tare / Gross weight	16
5.5.1 Net weighing: automatic tare	16
5.5.2 Net weighing: manual tare (PT)	18
5.6 Adding & reset	20
5.7 Entering ID-Code	22
5.8 Print out (option)	23
5.9 KG- LB switch	23
5.10 Changing the time and date (on the printout)	24
5.11 User settings	26
5.11.1 User menu explanation list	27
5.12 Supervisor menu	28
5.12.1 Supervisor menu explanation list	29
5.12.2 Overview power save settings (auto shut-off)	30
5.13 Alibi Memory	31
5.14 Relay function - optional	34
5.15 Maintenance	35

1. Introduction

Read this manual carefully. The installer must be informed of the contents of this manual. Always do things in the correct order. This manual should be kept in a safe and dry place. In case of damage or loss, the user may request a new copy of the manual from Lift-Rite.

2. Warning & Safety measures

When using the **LFTSC 2.0**, please observe carefully the instructions and guidelines contained in this manual. Always perform each step in sequence. If any of the instructions are not clear, please contact Lift-Rite.



- All safety regulations that apply to the pallet truck remain valid and unchanged;
- No weighing operations are allowed if any persons or objects are in the vicinity; around, under or close to the load;
- Any modifications done to the system must be approved in writing by the supplier prior to any work being completed;
- It is the sole responsibility of the purchaser to train their own employees in the proper use and maintenance of this equipment;
- Do not operate this unit unless you have been fully trained in its capabilities;
- Check the accuracy of the scale on a regular basis to prevent faulty readings;
- Only trained and authorized personnel are allowed to service the scale;
- Always follow the operating and maintenance instructions of the pallet truck and ask the supplier when in doubt;
- Lift-Rite is not responsible for errors that occur due to incorrect weightings or inaccurate scales.

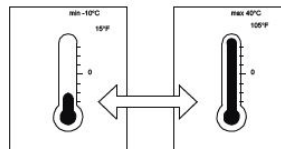

2.1 Lithium Ion Battery (option)

Important Safety Information



DANGER

- Use the specific Li-ion charger and observe the specified charging conditions when charging the battery.
- Avoid exposure to high temperature and keep away from fire.
- Do not deform, modify, or disassemble the battery.
- Do not connect the (+) and (-) terminals with metal objects.
- Do not put the battery in water.
- Do not drop the battery.



WARNING

- When a battery leaks, the battery should directly be wrapped up properly and treated as recyclable resource.
- When, due to leaking from the battery, liquid gets into your eyes, immediately clean the affected area with water without rubbing your eyes, and seek medical advice immediately.
- The charging of the battery will be stopped automatically if the battery is not fully charged after 8 hours (LED of the charger doesn't become green), immediately unplug the battery from the holder to stop charging. The battery or charger does not work properly; exchange battery or charger.
- Storing and/or using the battery outside the given temperature range may have a negative effect on the lifetime and/or the performance of the battery.
- Do not use a battery with leakages, deformation, or when any other abnormalities occur.
- Battery should be charged in a dry area.



WARNING

Charging can be carried out at any time regardless of the amount of charge remaining, but you should fully charge the battery at the following moments:

- **The battery is not fully charged at the time of delivery!** The battery can be used after fully charging with the specific Li-ion charger. The LED on the battery charger will become green when fully charged. Note: Before using the weighing system, be sure that the battery is fully charged.
- After the battery has become fully discharged. Storage of a fully discharged battery will shorten its life.

Specifications

Battery	Operating range
Nominal voltage / capacity	BA-14.8V-5A: 5 Ah (used for hand pallet trucks)
Operating temperature range	During use: -10°C - +50°C (14°F - 122°F) During charging: 0°C - +40°C (32°F - 104°F)

Operation

- **Normal charging**
 - Charging takes up to 6-7 hours for a full charge (a partially discharged battery will be fully charged sooner).
 - When the battery is fully charged, charger stops automatically.
 - After charging, the battery should be taken out of the charger.
- **Storing the battery**
 - When the weighing system is not used for a longer period, make sure the battery has approximately 70% of the battery capacity remaining. Take care not to let the battery become completely empty by charging it every 6 months.
 - Store the battery separated from the weighing system in an indoor place (approx. +10°C - +20°C) (50°F to 68°F) where it is not exposed to direct sunlight or rain.
- **Battery life**

The battery is a consumable item. The battery will gradually lose its capacity for charging after repeated use and after time has passed. If the operating time that the battery can be used becomes shorter and shorter, it has probably reached the end of its life.
Note: For replacement or additional battery pack, contact your distributor.
- **About used batteries**

Lithium-ion batteries are recyclable, valuable resources. For recycling of broken or used batteries, follow the local guidelines in your country. If you are not sure, please send back to the distributor for proper way of recycling.



Disposal information for countries outside the European Union

This symbol is only valid within the European Union. Follow local regulations when disposing used batteries. If you are not sure, consult the place of purchase.

3. System setup

3.1 Placing the battery pack in the pallet truck

The power supply to the system takes place through an exchangeable battery pack. With a completely charged battery pack, the total weighing time is about 75 hours for a Li-ion battery (for a system without a printer).

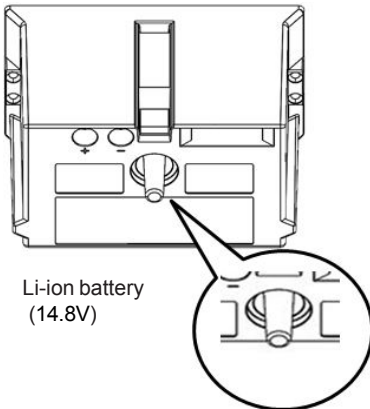
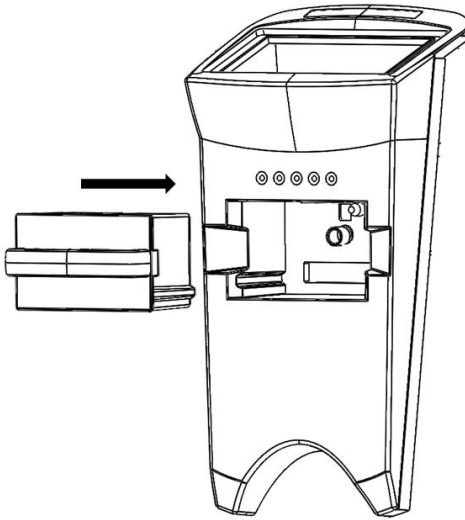

3.2 Switching on/off

1

ON

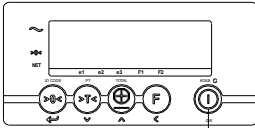

Start up the indicator. Press the on/off key.



2

OFF

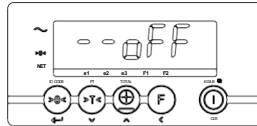

Switch off the indicator by pressing the on/off key for 3 seconds.



After 5 seconds all electronics are warmed up and you can start weighing.

4. Changing battery

4.1 Low battery indication

Exchangeable battery pack supplies power to the scale truck.

When the voltage level of the battery pack is running low, the low battery indicator will light up. The scale truck will switch off automatically after 2 minutes.

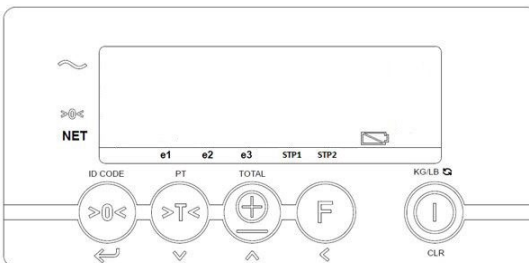

4.2 Charging the battery pack of the pallet truck

The system is equipped with a rechargeable battery pack and a smart charger. After charging for at least 8 hours, the charger will shut off when the battery pack is completely full. The red LED on the adaptor will change to green once the battery is fully charged.

First position the battery pack inside the charger module (1), then plug the adaptor into the main voltage (2).

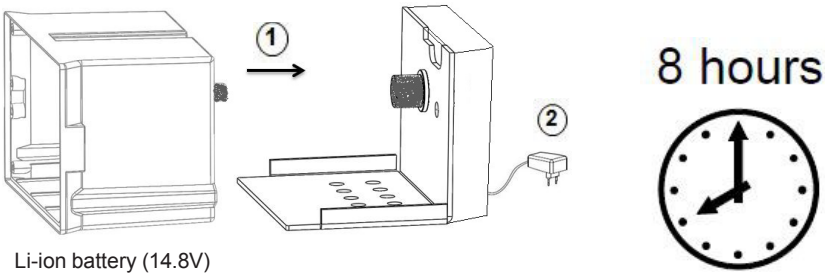

Li-ion battery (14.8V)

5. Use

5.1 Use (accurate weighing)

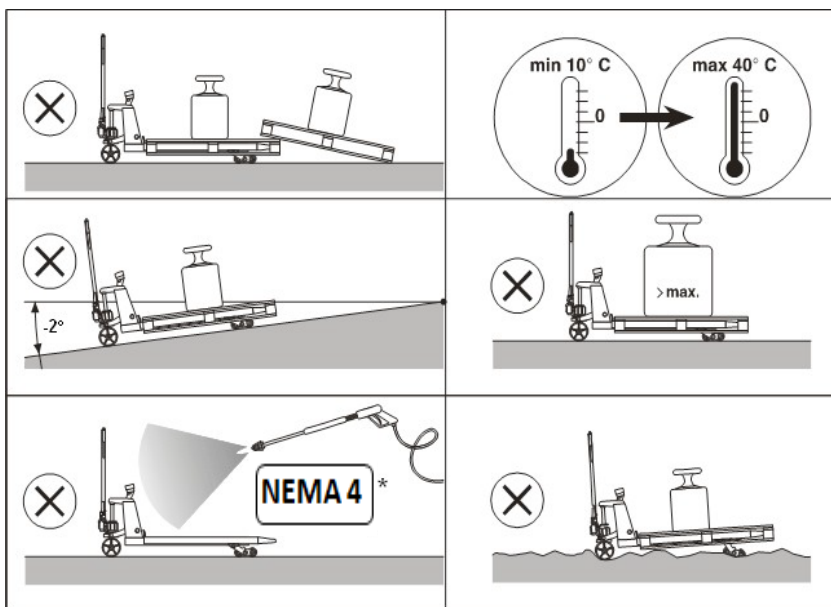
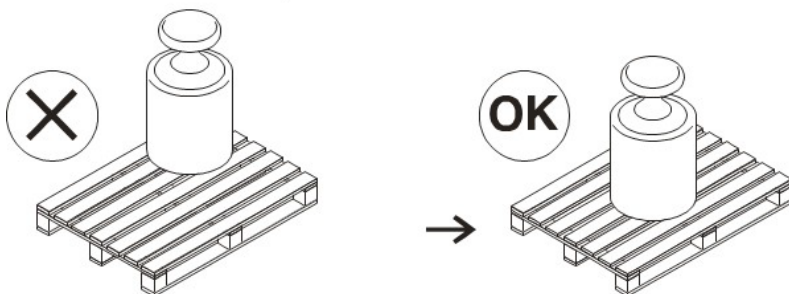

* excl. 

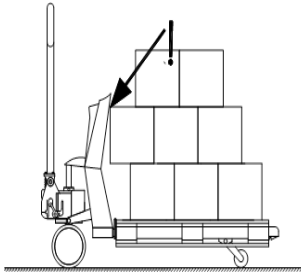

Wrong way of lifting the load

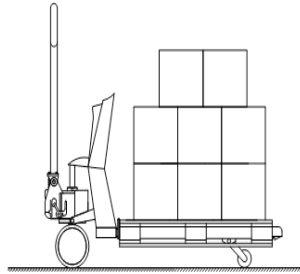

Correct way of lifting the load

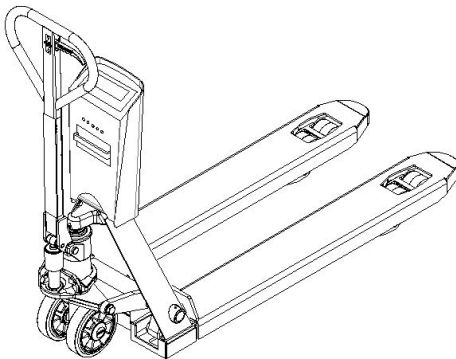

Check the zero reading before each weighing!

Before each weighing it is necessary to check whether the system is unloaded and free.

If the indicator does not determine the zero point automatically, it must be done manually using the >0< key.

5.2 Auto shut-off indicator / Sleep mode

1

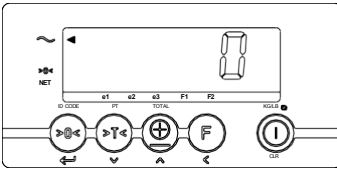

20 min. no action!



2

20 sec.

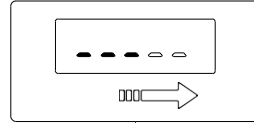

Countdown starts:
Press any key
during countdown to
cancel auto-shut-off
and go back to the
weighing mode.



3

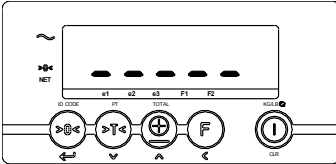

4

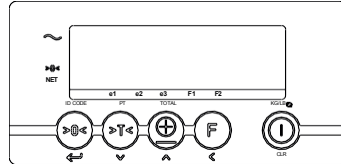

Indicator sleep.

5

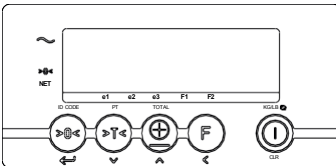







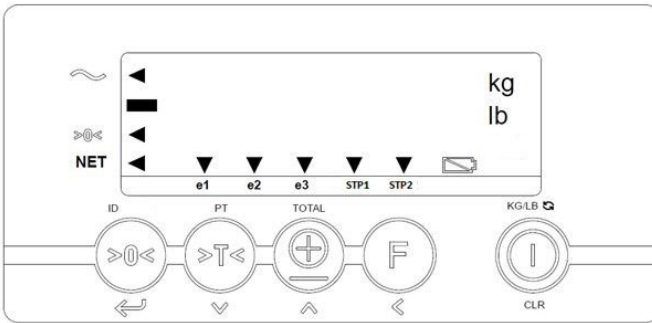



Press any key
to wake up
the indicator.







5.3 Indicator functions



-   the weighing system (including load) is stable
-  the weight shown is negative
- >0<**  the weight shown is within the zero range
- NET**  the display is showing the net weight
- e1**  displayed weight is in range 1 (option multi range)
- e2**  displayed weight is in range 2 (option multi range)
- e3**  displayed weight is in range 3 (option multi range)
- stp1**  setpoint 1 active (option function key activated)
- stp2**  setpoint 2 active (option function key activated)
- kg** displayed weight is in kilograms
- lb** displayed weight is in pounds
-  low bat indicator

Key functions

Each key has 2 operational and one entry function.

Standard function (short key press)	Key	Special function (long key press)	Value entering function (entry mode)
Zero setting		code entry	enter
automatic tare		pre-set tare	decrease the value of the digit flashing
print weight and add to the total		check subtotal and print/reset total	increase the value of the digit flashing
start special function if active		no function	shift to the next digit on the left
On switch And change to lb and kg		Off switch	clear entry

Important

Operation of a key is not accepted unless the weighing system is stable (and the "load stable" pointer lights up). This means that the indicator only executes commands with a stable load.

5.4 Error messages

ERROR MESSAGES

Display	Meaning	Out of error mode
Err01	Load cell signal is unstable	Automatic
Err02	Overload on full scale	Automatic after removing weight
Err03	Gross negative. This action is not allowed	Automatic
Err04	Out of zero range	Press any key
Err06	Input signal too high	Automatic after correcting input
Err08	Calibration out of range (negative)	Automatic
Err09	Calibration out of range (signal too low)	Automatic
Err10	Calibration count 2nd (3rd) point lower than count 1st (2nd) point	Automatic
Err14	Setpoint value 2 < setpoint value 1. This is not allowed	Automatic
CAL-J	Legal for trade version: action not allowed	When action is intended, remove jumper JP1 (attention: after this action a complete new calibration and stamping of the system is necessary)
Err98	Calibration point must be higher than previous one	Automatic
Err99	Action only allowed in start-up units	Automatic
----	Load cell signal negative	Lift up the forks from the ground
Err_L	Pallet truck is out of level (only legal-for-trade version)	Put the pallet truck into level position
	Battery pack is empty	Charge the battery pack
OimL	action not allowed (only legal for trade version)	automatic
ntEP	action not allowed (only legal for trade version)	automatic
SCALL	audit trail number out of range	Contact Lift-Rite Service department
ESoFt	Wrong combination of firmwares	Contact your dealer
EConF	P96 not set	Contact your dealer

5.5 Net / Tare / Gross weight

EXPLANATION: $Net(1) + Tare(2) = Gross(3)$

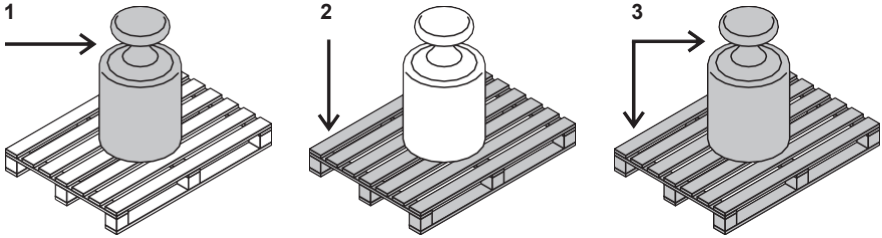

5.5.1 Net weighing: automatic tare

1

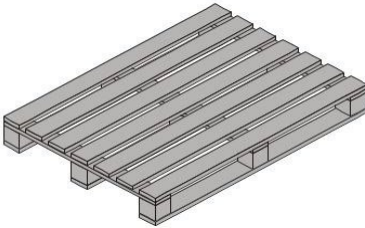

2

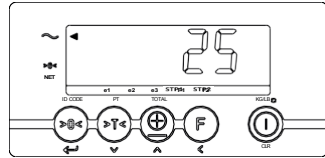

3

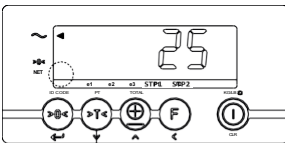

4

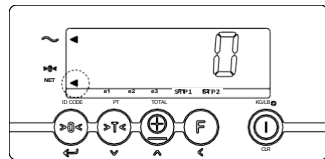

The indicator is set to zero.
The "NET" pointer shows that
the tare weight is activated.

5

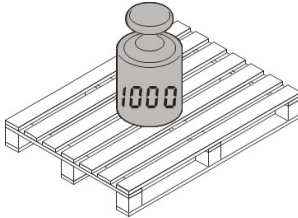

6

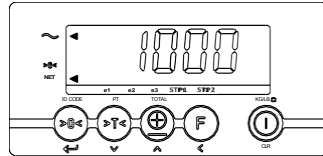

The display shows the net value of the weighed load.

7

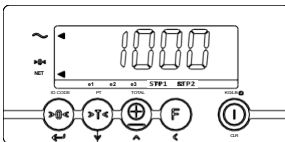

8

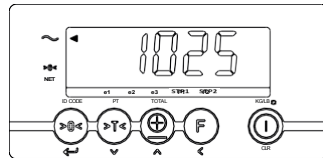

The gross weight is displayed again.

9

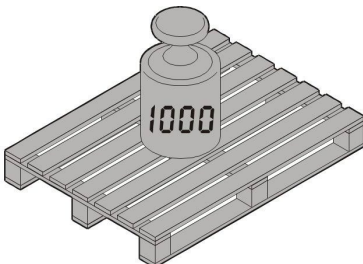

NOTE: for NTEP approved scale truck the tare will be erased automatically when the weight returns to gross zero! For the next weighing the tare must be activated again.

5.5.2 Net weighing: manual tare (PT)

1

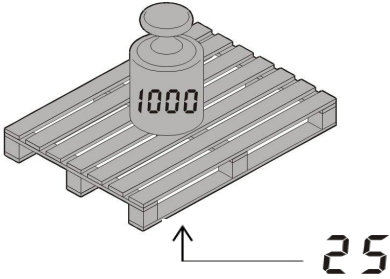

2

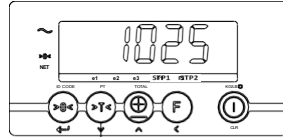

3 sec.



Press the
>T< key for 3
seconds.



3

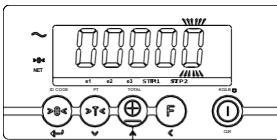

5x



Press the up
or down key
until the
desired value
is reached.

4

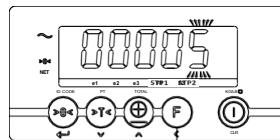

1x



5

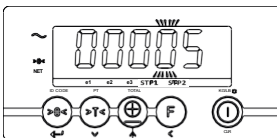

2x



Press the up
or down key
until the
desired value
is reached.

6

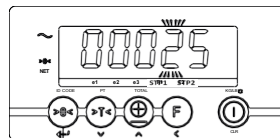

Press ENTER
to activate the
tare weight.

7

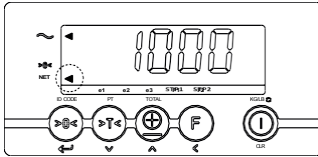

The "NET" pointer lights up.

8

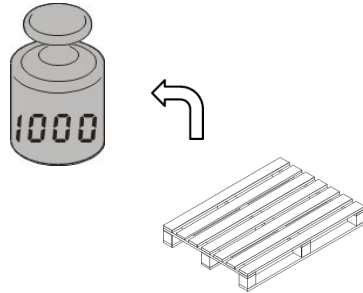

9

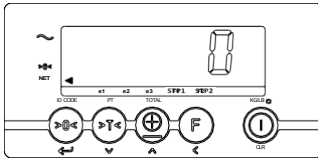

10

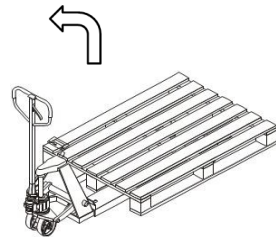

11

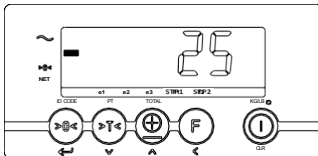

When the pallet truck is completely unloaded, the tare value is displayed negatively.

12

NOTE

For NTEP approved scale truck, the tare will be erased automatically when the weight returns to gross zero! For the next weighing, the tare must be activated again.

The last used preset tare value will remain in the preset tare memory. For re-using preset tare value, hold the >T< key for 3 seconds than press Enter.

5.6 Adding & reset

1

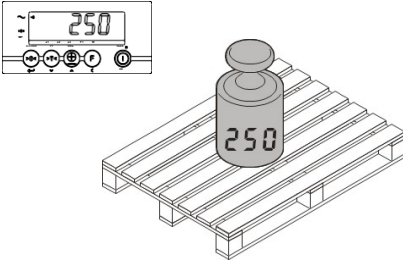

2

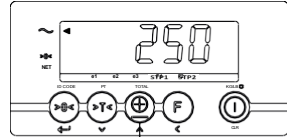

Press the **TOTAL** key to add the weight load to the total weight.

If a printer is installed, a printout will be made. The gross, net, and tare weights are printed.



3

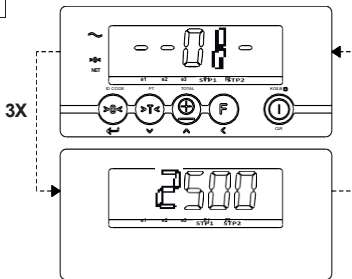

4

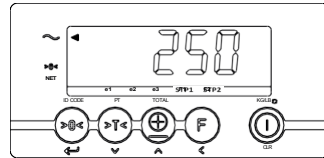

The display returns to the weighing mode automatically.

5

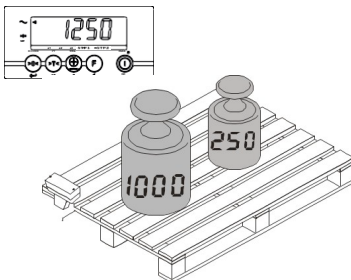

6

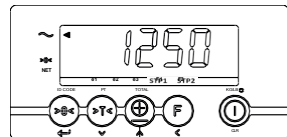

Press the **TOTAL** key to add the load weight to the total weight.

If a printer is installed, a printout will be made. The gross, net, and tare weights are printed.



7

3X

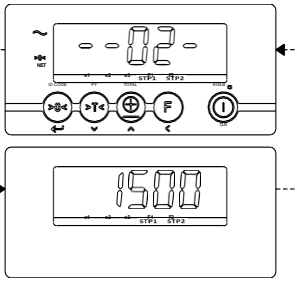

8

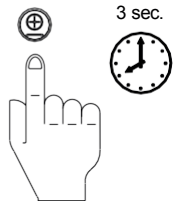
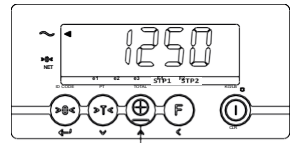

The subtotal
can be checked
by pressing the
TOTAL key for
3 sec.

9

3 sec.

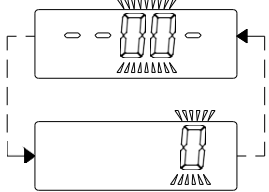
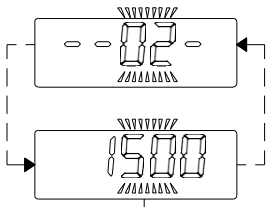

= RESET TOTAL & PRINT



= RESET TOTAL

NOTE: In case the total is not manually used or reset, the system will do this automatically as soon as the total number has reached 99 or as soon as the total weight has reached a value of 99999 kg.

5.7 Entering ID-Code

1

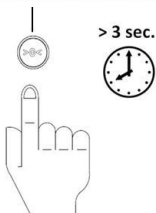
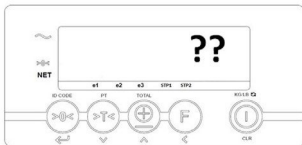

Press the ID-code key for 3 sec.

2



Last used code is shown (e.g. 20500).
Right digit is flashing.

3a



To accept the old value press Enter.

or: →

3b



Press < to scroll through the digits and press the up or down key until the desired value is reached.

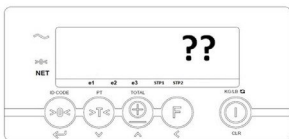

The code is activated, the indicator returned to the weighing mode.

Note:

If the code is '00000' it will be ignored and will not be printed on the print out.



To accept the new value press Enter.

5.8 Print out (option)

If the weighing system has been equipped with a printer, obtained and entered weighing data can be printed. Date and time are only printed out with the option board installed.

In the printout, a gross weight is indicated with the letters "B/G", and a net weight with the letter "N". A manually entered tare weight will also be printed out and is indicated with the letters "PT". The total weight is shown with the letters "TOT".

Standard printout
without code

B/G	1234.5	lb.
T	34.5	lb.
N	1200.0	lb.
*1		
Nr.	1	
10/07/03	17:45	

Standard printout
with code

CODE	12345	
B/G	1234.5	lb.
T	34.5	lb.
N	1200.0	lb.
*1		
Nr.	1	
10/07/03	17:45	

Total printout (always without code)

Tot. B/G	1234.5	lb.
Tot. T	34.5	lb.
Tot. N	1200.0	lb.
*1		
Tot. Nr.	999	
10/07/03	17:45	

*1 Note: in case of a legal for trade unit, the alibi number will be printed here.

5.9 KG- LB switch

1

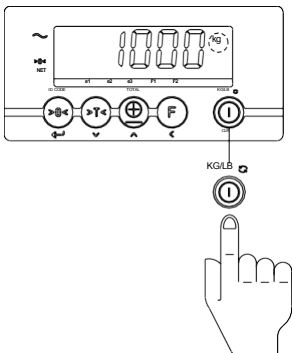

2

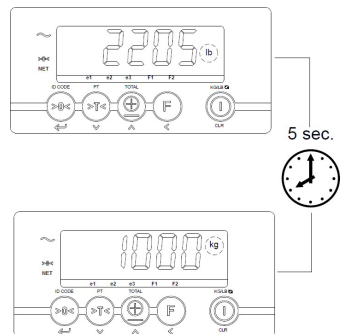

5.10 Changing the time and date (on the printout)

1

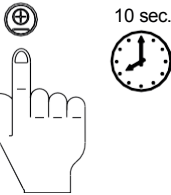
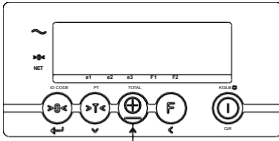

The user menu can be entered by pressing the TOTAL key for 10 sec.

2

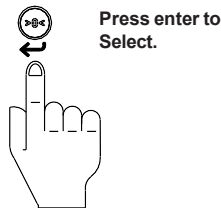
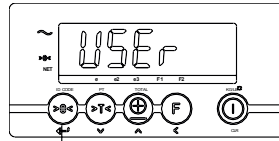

Press enter to Select.

3

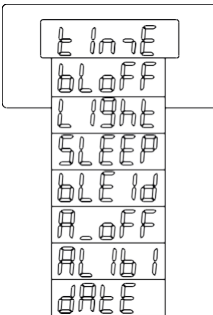

Select "TIME" in the user menu to change the time.

4

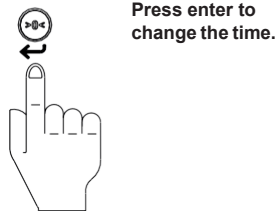
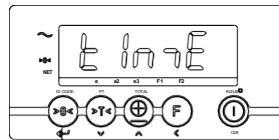

Press enter to change the time.

5

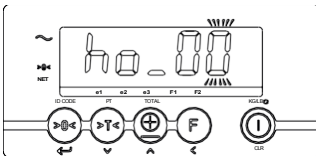

The display will show "ho_00" or the previous hour time setting

6

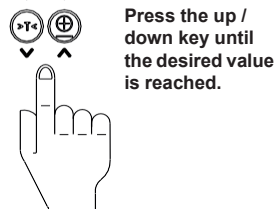
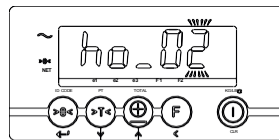

Press the up / down key until the desired value is reached.

7

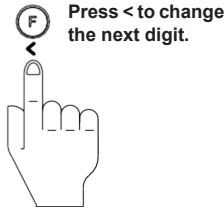
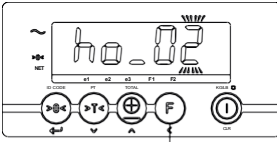

8

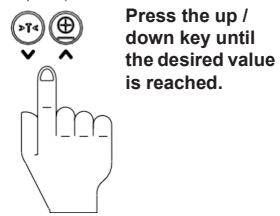
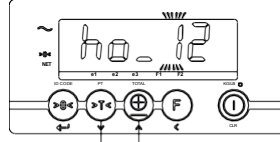

9

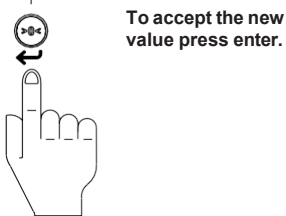
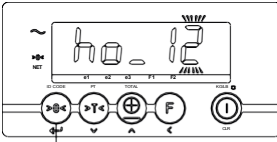

10

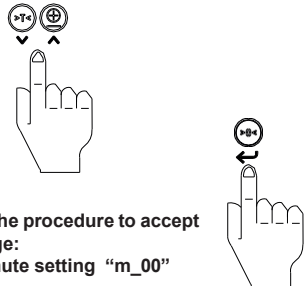
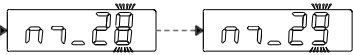

11

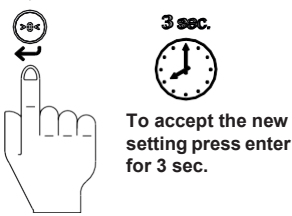
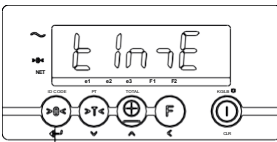

12

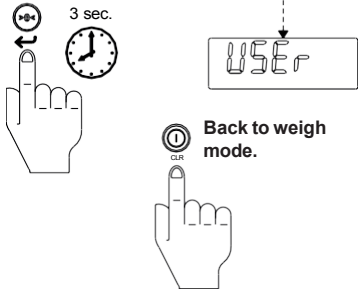
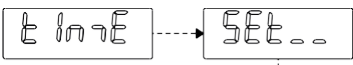

5.11 User settings

1

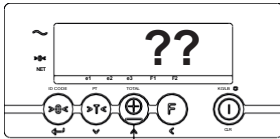

10 sec.



The user menu can be entered by pressing the TOTAL key for 10 sec.



2

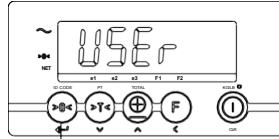

Press enter to Select.



3

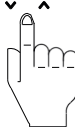
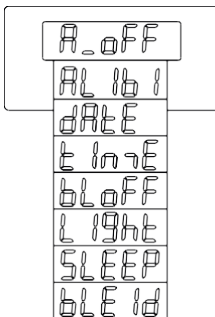

These user settings can be changed if desired. See next pages.

a

▶ EXIT & SAVE

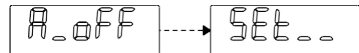

3 sec.

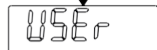

Back to weigh mode.



b

▶ EXIT WITHOUT SAVING



Back to weigh mode.



5.11.1 User Menu explanation list

USER menu explanation list				default
User menu	function	remark	settings	1AD
A_OFF	setting of the auto power off function in minutes	setting to 00 means always on (higher power consumption)	00-99	30
BLEId	read out the Bluetooth unique addresses of the slave module on the mainboard or fork module 1/2	scrolling in display when selected	SLAvE/For-1/For-2	SLAvE
Alibi	read out the alibi memory (only for OIML or NTEP systems) by entering the alibi no.	n.a.	n.a.	n.a.
dAtE	setting the date	n.a.	da_xx/m_xx/YE_xx	n.a.
timE	setting the time	n.a.	ho_xx/m_xx	n.a.
bLoFF	selecting the auto off time off the backlight in seconds	setting to 0 means always on (higher power consumption)	0/20/40/80/160/320	20
LigHt	selecting the backlight brightness in %	setting to 0 means always off	0/25/50/75/100/125/150/175/200	100
SLEEP	setting the sleep time in minutes	setting to 00 means never in sleep mode	00-99	20

5.12 Supervisor menu (password protected *1)

*1 The Supervisor menu is password protected since version 1.01. Earlier versions of the software are not password protected. Please contact Lift-Rite Service department for the password.

1

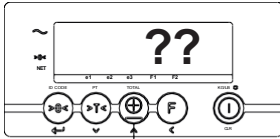

The user menu can be entered by pressing the TOTAL key for 10 sec.

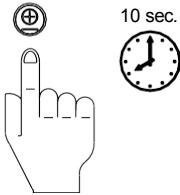

2

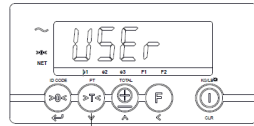

Press to change to Supervisor menu.



3

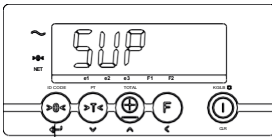

Press enter to Select.



4

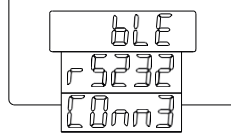

Select to change the setting.



5

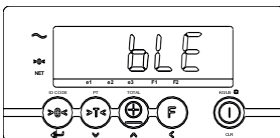

Press enter to Select.



6

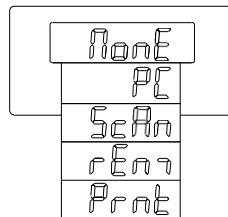

Select to change the setting.



7

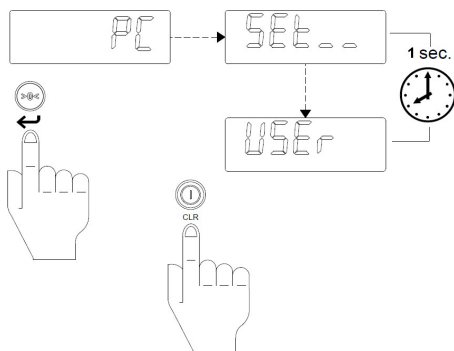

5.12.1 Supervisor menu explanation list3

SUP(ervisor) menu explanation list				default
Sup menu	function	remark	settings	
BLE	setting the functionality of the Bluetooth port integrated on the mainboard addressed as [SLAVE]	for sub-functions see underneath	PC/ScAn/rEm/Prnt/NonE	PC bidir
rS232	setting the functionality of the RS232 port for wired options	for sub-functions see underneath	PC/ScAn/rEm/Prnt/NonE	Prnt Prot-ASCII LF04 LAYou-Std bArcd-NONE SuPPL-Pr_On
COm3	setting the functionality of the COM 3 port for stacked options	for sub-functions see underneath	PC/ScAn/rEm/Prnt/NonE	NonE
Sub-functions				
PC	selecting the PC functionality	bidir: select if using PC commands from a host PC/Terminal rdc-A: select if using the RDC-application with acknowledgement rdc-N: select if using the RDC-app. without acknowledgement	bidir/rdc-A/rdc-N	bidir
ScAn	selecting the the scanner functionality	not available. Reserved for future use	n.a.	n.a.
rEm	selecting the remote display functionality	select for continuously sending of display values to a RAVAS remote display	n.a.	n.a.
Prnt	select the printer functionality	Prot: select if no. off linefeeds need to be changed LAYou: select if layout needs to be changed	0-8 Std/tot	4 Std
		bArcd: select if a barcode is required in the print. You may choose to have the net weight, the gross weight or the net and gross weights printed out as a barcode. The values will also be printed out as tekst. After selecting a barcode you need to enter the height of the barcode and the family type	NONE/Net/Gross/NETGr	NONE
		Height	20- 90	50
		Family: only 2 family types are available > Barcode 128 and Barcode 39. For printer type XTRA select 128-1 or 39-1, for printer type MPP8250 and 7810v select 128-2 or 39-2.	128-1/128-2/39-1/39-2	128-2
		SuPPL: select if the power supply to the printer needs to be changed	Pr_On/Cont	Pr_On
NonE	select no functionality for this port			

5.12.2 Overview power save settings (auto shut-off)

Overview of Auto shut-off and Sleep settings. The settings mentioned below are the standard settings and advised for optimal use. These settings can be changed in the user menu, as described above.

Auto Shut-off & Sleep Settings		
		Lift-Rite Model LFTSC 2.0
Options -> WiFi / RS / Bluetooth	SLEEP	0
	A_OFF	30
No options	P60	14.8
	SLEEP	20
	A_OFF	30



5.13 Alibi Memory

The scale truck indicator has the possibility of an alibi memory. The alibi memory will only be used when parameter 13 is set for OIML or NTEP. If parameter 13 is set for 'NONE', the alibi memory will remain unused.

The indicator stores every weighing in its alibi memory and adds a unique number to it. If the alibi memory is activated, it will affect the RDC protocol. The PC protocol or the Printer protocol depending on the setting of parameters in the supervisor menu.

The data stored in the alibi memory are:

1. Date > this is the date in format dd\mm\yy (EU) or mm\dd\yy (US).
2. Time > this is the time in format hh:mm.
3. Gross weight > this number always consists of 5 digits, a possible decimal point (as part of the 5 digits), the unit (kg or lb), and the positive or negative sign.
For example: +0233.5kg or -00136.lb.
4. Net weight > this number always consists of 5 digits, a possible decimal point (as part of the 5 digits), the unit (kg or lb), the positive or negative sign, and whether it was a calculated net or a measured net.
For example: +0233.5kgC or -00136.lb_. The 'C' stands for calculated and is sent along when a preset tare value was active. If there is no preset tare value active, a blank (space) is put behind the kg (or lb).
5. Tare weight > this number always consists of 5 digits, a possible decimal point (as part of the 5 digits), the unit (kg or lb), the positive or negative sign, and whether it was a preset tare or a measured tare.
For example: +0233.5kgP or -00136.lb_. The 'P' stands for preset tare and is sent along when a preset tare value was active. If there is no preset tare value active, a blank (space) is put behind the kg (or lb).
6. Code > this is the 5-digit code that can be entered by keying in. If no code is activated, it will show '0'.
7. Alibi number > this is a 4 digit number which is generated by the indicator itself. It will start at '0001' and increase with every weighing up to '9999'. When this number is reached, it will start at '0001' again.

The alibi memory is 1Mbit big. It can contain about 7000 weighings. The alibi memory works with FIFO (first in first out). When it becomes full the oldest data will be first overwritten, and it will be assigned subsequent digit until it resets when the display reaches 9999.

For reading out the data saved in the alibi memory please follow next steps:

1

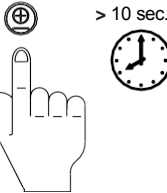
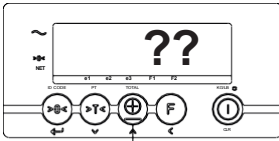

The user menu can be entered by pressing the TOTAL key for at least 10 sec.

2

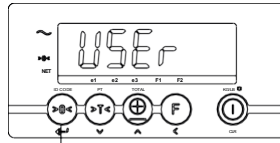

Press enter to Select.

3

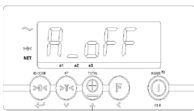

Press the up /down key until the display shows the user setting 'ALibi'.

4

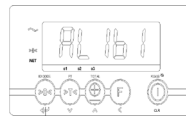

Press enter to confirm.

5

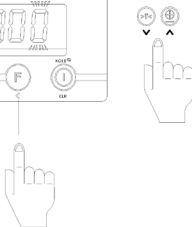
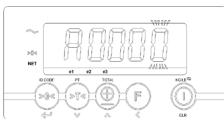

Enter the requested alibi number by using the up and down keys and the shift key. In this example we enter alibi number 2'.

6

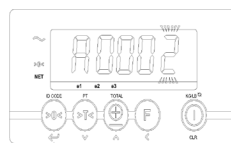

Press enter to confirm.

7

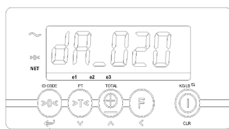

The display now shows the date (first day, then month and year) and the time (first hours, then minutes) of the weighing with alibi number 02.

Press enter to continue to the month.

8

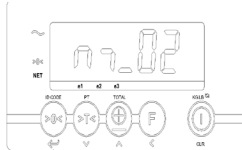

Press enter to continue to the year.

9



Press enter to continue to the hour.

10



Press enter to continue to the minute.

11

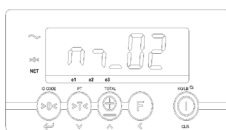

Press enter to continue.

12

For 0.5 sec the display shows the text 'Gross'.
Next the display shows the gross weight.



Press enter to continue.

13 For 0.5 sec the display shows the text 'Net' or 'Net_C'.
Next the display shows the net weight.
Net: weight is measured.
Net_C: weight is calculated.



Press enter to continue.



14 For 0.5 sec the display shows the text 'tArE' or 'PtArE'.
Next the display shows the tare weight.
tare: weight is measured.
Ptare: weight is keyed in.

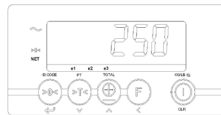

Press enter to continue.



15 For 0.5 sec the display shows the text 'Code'.
Next the display shows the code used. If no code was used the display shows '0'.

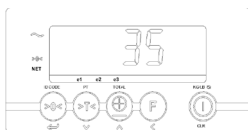

The indicator will automatically return to the user setting 'Alibi' if no code was used the display shows '0'.



16

 A diagram of the 3200 indicator's LCD display. The display shows the text 'ALibi' in large characters. Below the display, there are several control buttons: a left arrow, a right arrow, a plus sign, a minus sign, a function 'F', and a power/enter button. A hand icon is shown with the index finger pointing to the power/enter button, with a '2x' label next to it.

Press enter to search for another weighing or press 'CLR' 2x to return to the normal weighing mode.

5.14 Relay function - optional

The 3200 indicator has the possibility to setup limit values for relay settings. The different options for relay settings are:

- overload on gross weight
- overload on net weight
- dosing / filling with manual tare & start
- dosing / filling with automatic tare & start

5.15 Maintenance

The maintenance guidelines for normal pallet trucks apply to the chassis of the mobile weighing system. The integrated weighing system still functions when the chassis is damaged by overloading

Main guidelines:

- Because the steering wheels are mounted in the front, pulling of the pallet truck is preferred over pushing it.
- When the lifting mechanism is not used, the handle should be kept in the neutral, middle position. This prolongs the life span of the sealings.
- The weighing system meets the protection class IP65. This means that dust or moisture (rain or water beam from all sides) will not influence the operation of the electronics. However, high-pressure cleansing in combination with warm water or chemical cleansers will lead to the entry of moisture and therefore negatively influence the operation of the system.
- Only specialists may undertake any welding. This is to avoid damage to electronics and load cells.
- The bearings of the wheels (non-polyurethane) and the pivoting points of the levelling bar of the loading wheels must be cleansed and greased regularly.
- All safety regulations that apply to the pallet truck remain valid and unchanged;
- No weighing operations are allowed if any persons or objects are in the vicinity; around, under or close to the load;
- Any modifications done to the system must be approved in writing by the supplier prior to any work being completed;
- It is the sole responsibility of the purchaser to train their own employees in the proper use and maintenance of this equipment;
- Do not operate this unit unless you have been fully trained in its capabilities;
- Check the accuracy of the scale on a regular basis to prevent faulty readings;
- Only trained and authorized personnel are allowed to service the scale;
- Always follow the operating, maintenance and repair instructions of the pallet truck and ask the supplier when in doubt;
- Lift-Rite is not responsible for errors that occur due to incorrect weightings or inaccurate scales.

