

# LIFT-RITE®

**OWNER'S MANUAL, OPERATING INSTRUCTIONS MANUAL,  
and REPLACEMENT PARTS MANUAL**

**Lift-Rite® Legal for Trade Scale Hand Pallet Truck - Model LFTSC**

**3P - 21904370.192001-05 and below  
5P - 21904371.192001-25 and below**



This publication, 1234959D, applies to the Lift-Rite® LFTSC Hand Pallet Trucks, and to all subsequent releases of this product until otherwise indicated in new editions. Changes occur periodically to the information in this publication.

To order additional copies of this manual, part number 1234959D, contact your local authorized Lift-Rite Sales and Service Center.

If you need assistance with your lift truck, contact your local authorized Lift-Rite Sales and Service Center.

For more information please visit [www.liftright.com](http://www.liftright.com)

©2022

---

## TABLE OF CONTENTS

---

BEFORE YOU BEGIN	3
DELIVERY INSPECTION	3
OPERATING INSTRUCTIONS	3
SAFETY	4
SYSTEM SETUP	5
Mounting the Pump Handle	5
The Battery	6
OPERATION MANUAL	7
USING THE WEIGHING HAND PALLET TRUCK	7
Accurate Weighing	7
Taking the System into Operation	8
Maintenance	8
TOUCH PANEL INDICATOR	9
The Display	10
The Touch Panel	11
IMPORTANT	11
Error Messages	12
INDICATOR FUNCTIONS	13
Graduation	13
Before Weighing: Check Zero Point	13
Gross Weighing	13
Net Weighing: Automatic Tare	13

---

Tare Weights	14
Sample Tare Entry	14
Piece Count: Sampling	15
Piece Count: Enter a Piece Weight	15
Summing	16
Change Units	16
PRINTER (OPTION)	17
The Print Out	17
Changing the Thermal Paper Roll	18
Changing the Time and Date on the Print-out	19
TROUBLESHOOTING	20
SPARE PARTS EXPLODED VIEW	26
SPARE PARTS LIST – Weighing Hand Pallet Truck Model LFTSC	27
CALIBRATION	28
Calibration Instructions Indicator	28
Defining Zero	28
Single Point Calibration	28
Calibrating the single point	29
Multi-Point Calibration	30
PARAMETER SETTINGS	31
LIFT-RITE® LEGAL FOR TRADE SCALE TRUCK (LFTSC) WARRANTY CERTIFICATE	35
SELECTED OSHA REGULATIONS FOR LIFT TRUCKS	36

---

## BEFORE YOU BEGIN

---

Always follow your facility's rules regarding wearing Personal Protective Equipment such as safety shoes and protective glasses whenever operating, working with, or assembling or dismantling hand pallet trucks.

---

## DELIVERY INSPECTION

---

Visually inspect the frame components and hydraulic unit for damage during shipment by carrier. If damage is evident, notify delivering carrier immediately and file necessary claims. Test the manual pump for proper operation. **If the hydraulic pump does not respond to movement of the handle, an air lock may have developed during shipping. To remedy this, go to the user friendly TROUBLESHOOTING guide in this manual.**

---

## OPERATING INSTRUCTIONS

---

*(Read and understand prior to using this product)*

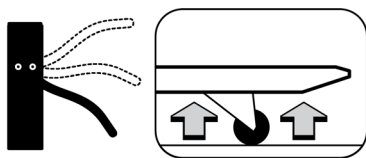

→ To raise the load, push down on the fingertip control. Pump the handle to raise the load from the floor.

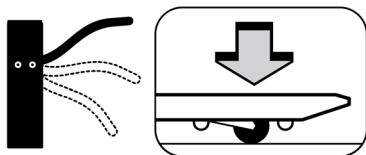

→ To lower the load, pull up on the fingertip control.

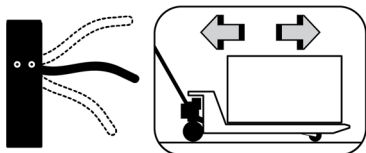

→ For free handle movement, place the fingertip control in the neutral position.

**NOTE:**

The neutral position disengages the pump from the lifting mechanism. This frees the handle, which makes pulling loads easier. In addition, the pump is not subject to shock pressures while the truck is in motion.

## **SAFETY**

---

### ***(read and understand prior to using this product)***



- Read and obey all labels on this product. If you have any questions about these, ask your supervisor.
- Do not operate this hand pallet truck unless you are authorized and trained to do so.
- Never overload your hand pallet truck. Stay within its rated capacity.
- Do not operate this truck if damaged or not in proper working order.
- Distribute the load evenly on the forks. Do not concentrate loads at one point or load one fork more than the other.
- When the load impairs visibility, the hand pallet lift truck should be pulled and not pushed.
- Always look where you are operating. Keep a clear view.
- Only handle loads on flat level surfaces. Do not use a loaded truck on inclines or declines.
- Never carry passengers.
- Never put your feet, hands, or any other body part under the frame assembly.
- Always yield right of way to pedestrians.
- Do not allow your hand pallet truck to drop from one level to another. Even a drop of 1 in. (25 mm) more than doubles the effective load momentarily and results in a loading that can bend or break components.
- Move loads only with the hand pallet truck in its lowest position.
- Always make sure that the load is stable before moving to eliminate the opportunity for load shift.
- Use extreme care when rounding corners. Too fast a speed could cause a hand pallet lift truck to tip. If loaded, the load could shift and fall.
- When not in use, fully lower the forks.
- Never lift a heavy load with just the points of the forks. This could damage the electronic weighing elements permanently.
- Never weigh without a pallet. This could affect the accuracy of the weighing result.
- The unit may be loaded with weights up to 5000 lb. (2268 kg).
- Do not operate the weighing system on ramps, inclines or declines, without the addition of our optional parking brake.
- Do not operate the weighing system while others are on or near the unit. **No riding!**
- Do not use the weighing system in potentially explosive areas.
- Do not weld or make changes to the weighing system without consulting the supplier.
- Check the accuracy of the scale on a regular basis to prevent faulty readings.
- Never lower loads if you are unsure you can place the load on a stable surface. Personal injury may result from placement on an unstable environment.
- Always remain with the scale during dosing applications. Incorrect lifting of the pallet can cause overflowing.
- Lift-Rite is not responsible for errors that occur due to incorrect weights or inaccurate scales.

---

**SYSTEM SETUP**

---

**Mounting the Pump Handle**

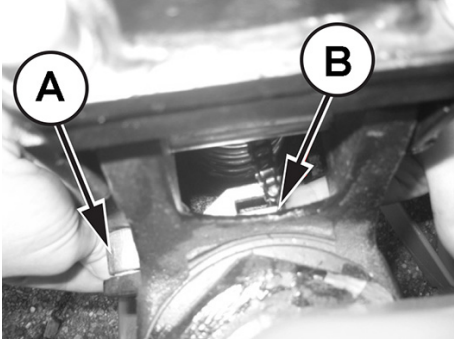
	
<p>1. Make sure the lever is pushed down to the "pump" position.</p>	<p>2. Thread the chain through the hole in the triangle and through the hole in the axle.</p>
	
<p>3. Place the handle bar onto the triangle and insert the bolts. 4. Tighten the bolts firmly.</p>	<p>5. Push the silver part "A" on the outside of the pump downwards. 6. At the same time; insert the chain into the open side of the slot "B" on the inside of the pump.</p>

## The Battery

The power supply to the system takes place through an exchangeable battery pack. A completely charged battery should operate for a total weighing time of about 35 hours (on a system without a printer).



**CAUTION! - When the voltage level of the battery is running low, the display shows "LO-BA". When the battery is completely empty, the weighing system shuts off.**

It is necessary to charge the battery for at least 6 hours before the first use. Recharge the battery when the LO-BA indicator comes on.

If you use the system in shift work or if the system has a built-in printer, it is recommended to purchase a supplementary battery pack.

The battery should be charged using the adapter supplied with the charger. When the battery is charging, the LED on the charger is lit. When the LED turns off, the battery is fully charged.

It is not possible to overcharge the battery because the charger shuts off automatically.



**OPERATION MANUAL**

**USING THE WEIGHING HAND PALLET TRUCK**

**Accurate Weighing**

The weight must be centered over the forks of the pallet truck and lift freely: without touching the housing of the indicator or other pallets.

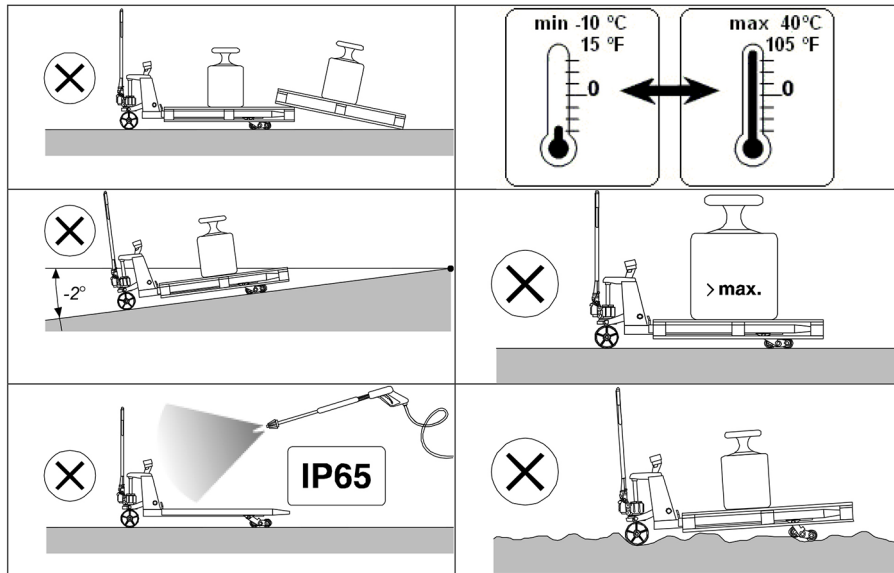
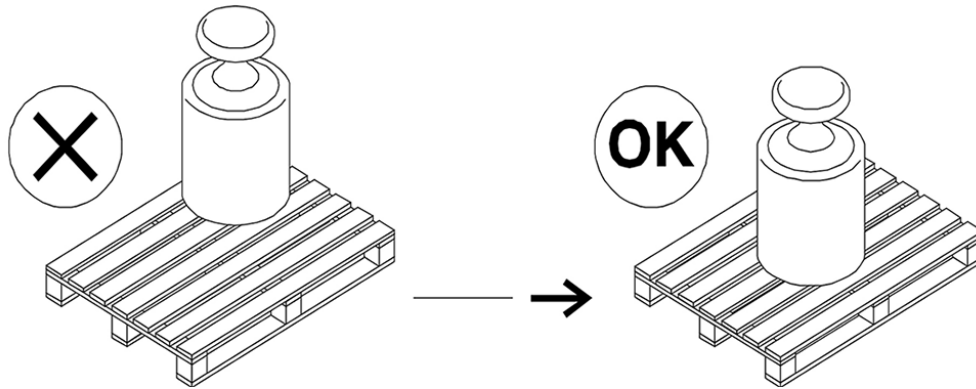

Fast temperature changes should be avoided because condensation may form in the electronics. During acclimatization the indicator must be turned off.

### **Taking the System into Operation**

To activate the scale, turn it on using the on/off (ⓘ) button on the terminal.

After 3 to 5 minutes the electronics and load cells have reached the operational temperature. Before this, inaccuracies of up to 0.3% may occur.

It is recommended not to lift loads before the zero-point correction is executed. (See "TROUBLESHOOTING" on page 20).

### **Maintenance**

The maintenance guidelines for normal pallet trucks apply to the chassis of the mobile scale. The integrated scale functions even though the chassis is damaged by overloading.

Main guidelines:

- Because the steering wheels are mounted in the front, pulling of the pallet truck is preferred above pushing it.
- When the lifting mechanism is not used, the handle should be kept in the neutral (middle) position. This prolongs the life-span of the seals.
- The scale meets up to the protection class NEMA 4/IP65. This means that dust or moisture (rain or water beam from all sides) does not influence the operation of the electronics. However, high-pressure cleansing in combination with warm water or chemical cleansers leads to the entry of moisture and has a negative influence on the operation of the system.
- To avoid damage to load cells and electronics, only the Authorized Service Center may undertake any welding.
- The bearings of the wheels (non-polyurethane) and the pivoting points of the leveling bar of the loading wheels must be cleansed and greased regularly.

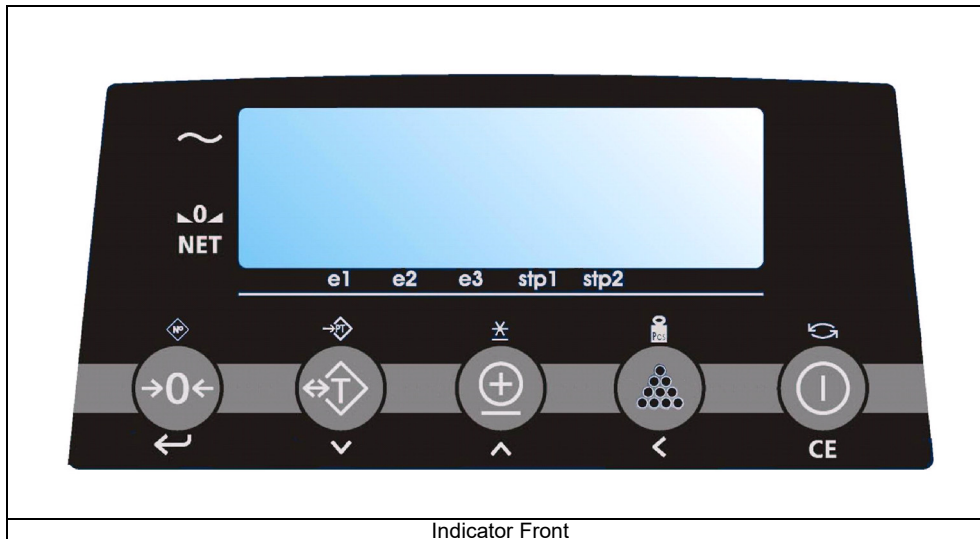









**TOUCH PANEL INDICATOR**

There are three display-modes: lbs., kg, or the number of pieces.

Also, the battery sign is integrated in the display to show a low battery status.





## The Display

By means of eight pointer bars the display shows:

		the scale (including load) is stable
		the weight shown is negative
ZERO		the weight shown is within the zero range
NET		the display is showing the net weight
e1		the weight shown is in range 1
e2		the weight shown is in range 2
e3		the weight shown is in range 3
stp		Set-point 1 is activated
stp2		Set-point 2 is activated

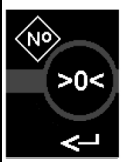
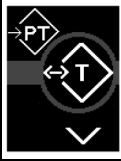
**The Touch Panel**

Each key has two operational and one entry function.

Key	Function level 1 (short key press)	Function level 2 (long key press)	Function level 3 (entry mode)
	zero setting	code entry	enter
	automatic tare	pre-set tare	decrease the value of the digit flashing
	print weight and add to the total	check subtotal and print total	increase the value of the digit flashing
	sampling a piece weight	enter a piece weight	shift to the next digit on the left
	on/off switch	Change units mode	clear entry

**IMPORTANT**

Operation of a key is not accepted unless the scale is stable (and the “load stable”  pointer lights up). This means that the indicator only executes commands with a stable load.



**Warning: When the weighed load surpasses the pre-set maximum, the display shows: "Err02". To prevent damage to the indicator or load cells, the scale must be unloaded immediately.**

## Error Messages

Displayed error	Meaning	Out of error mode
Err01	Load cell signal is unstable	Automatic
Err02	Overload on full scale	Automatic after removing weight
Err03	Gross negative. This action is not allowed	Automatic
Err04	Out of zero range	Press any key
Err05	Sampling accuracy too low	Press any key
Err06	Input signal too high	Automatic after correcting input
Err07	Input signal too low	Automatic after correcting input
Err08	Calibration out of range (negative)	Automatic
Err09	Calibration out of range (signal too low)	Automatic
Err10	Calibration count 2nd (3rd) point lower than count 1st (2nd) point	Automatic
Err14	Set-point value 2 < set-point value 1. This is not allowed	Automatic
Err98	Calibration point must be higher than previous one	Automatic
Err99	Action only allowed in start-up units	Automatic

## INDICATOR FUNCTIONS

### Graduation

From 0 to 3000 lbs. (0 to 1361 kg), the weight is shown in 1 lb. (0.5 kg) increments.

From 0 to 5000 lbs. (0 to 2268 kg), the weight is shown in 2 lb. (0.9 kg) increments.

### Before Weighing: Check Zero Point

Before each weighing, it is necessary to check whether the system is unloaded and free. The indicator is fitted with an automatic zero correction. This means that small deviations of the zero point corrects automatically. If the indicator does not determine the zero point automatically, it must be done manually by pressing the >0< key.

### Gross Weighing

After lifting a load, the display shows the gross value of the weighed load.

### Net Weighing: Automatic Tare

The indicator offers the possibility to reset tare weights to zero automatically. This way added or subtracted weights can be determined.

- Lift load.
- Press key  $\leftrightarrow T$  .
  - The indicator is set to zero.
  - The "NET" pointer shows that a tare weight is activated.
- Place or remove the net load.
  - The display shows the net value of the weighed load.
  - When load is removed, a negative weight is shown.
- By pressing the  $\leftrightarrow T$  key again, the gross weight is shown.

## **Tare Weights**

A tare weight can be entered at any time, either in a loaded or unloaded situation.

### **Sample Tare Entry**

- Pick up the empty pallet, container, or item that you want to delete from the Net Weight.
  - Tap the "T" Tare Button.
  - Indicator shows "0" zero.
  - When the Weighing Hand Pallet Jack is emptied/off-loaded, the indicator shows the negative Tare Weight.
  - Tare Weight saves until the system is re-zeroed.
- To delete the Tare Weight, empty the Weighing Hand Pallet Jack and tap the "0" zero button.

### **Or**

- Press the →PT key until the display changes and the last digit is flashing (approx 3 seconds).
- The display shows the current tare value.
- The right digit flashes.
- Press the ^ key to go up a value or press the v key to go down a value until the required value is reached for that place.
- Press < to change to the next digit.
- Repeat this procedure until the required tare value is shown.
- Press ENTER (↵) to activate the tare weight.
  - The tare weight activates.
  - The "NET" pointer lights up.
  - When the system is loaded, the net value is shown in the display
  - When the system is unloaded, the read-out shows the negative value of the given tare.
  - The entered value remains active until a new tare weight is entered (display shows the new net weight).
- Press the ↔T key to return to gross weighing mode.





**Piece Count: Sampling**

If an unknown piece weight is to be determined, you may do this by sampling a certain number of pieces. The number of pieces taken from or placed on the scale determines the accuracy of the sampling. The total weight of the pieces taken from or placed on the scale for the sampling should be no less than 9 to 10 lbs. (4.1 to 4.5 kg). The greater the weight difference, the greater accuracy. The standard sampling amount is 10 pieces, but this number can be increased up to 95 pieces.

- Press the  key.
  - The display shows "add10". The "lb." pointer changes to "pcs".
- Take or place 10 pieces from/on the scale and press the ENTER (←) key.
  - The sampling is done and the display shows the total number of pieces on the scale.

**Or**



- Press the  key or the  key to change the number of pieces to add.
  - The display shows the new value to add. (For example "add 50").
- Take or place 50 pieces from/on the scale and press the ENTER (←) key.
  - The sampling is done and the display shows the total number of pieces on the scale.

To return to the normal weighing mode, press the  key for 3 seconds.

**Piece Count: Enter a Piece Weight**

- Press the  key for 3 seconds.
  - The last used piece weight is shown with the right digit flashing.
- Press ENTER (←) to accept the old value.
  - The display shows the number of pieces currently on the scale.

**Or**

- Change the piece weight value by using the  or  and < keys.
  - The display shows the new piece weight.
- Press ENTER (←) to accept the new value.
  - The display shows the number of pieces currently on the scale.

To return to the normal weigh mode, press the  key.

## Summing

The indicator offers the possibility to add weighings and show the total weight. When a tare weight is active, the net weight is added automatically.

- Load the system with the weight that should be added.
- Press the **⊕** key to add the weighed load to the total weight.
  - The display shows the message "ADDED" and after a short delay returns to the weighing mode.

**NOTE:** Note that no weight can be recorded twice. The system needs to be returned to the net zero-range before another weight can be added up.

Press the **\*** key for 3 seconds to check the subtotal.

- The display shows the net total weight and the number of weights totaled so far repeatedly for 3 seconds.
  - If the **⊕** key is pressed during this period, the total is printed out (if option is installed) and reset to 0.
  - If the "CE" key is pressed during this period, the total is reset but not printed out.
  - If no key is pressed during this period, the subtotal stays in memory and the system returns to the weighing mode after 60 seconds.

## Change Units

The system is set to start up in 'lbs.' instead of 'kg'. However you may, at any time in the weighing mode, change to the second unit (lb. ↔ kg or kg ↔ lb.).

- Press the **↻** key for 3 seconds.
  - The display shows the current weight in the new units for 5 seconds and then automatically changes back to the start up units.

**NOTE:** The same key is used to change from the piece counting mode back to the weighing mode.

**PRINTER (OPTION)**

The Model LFTSC may be equipped with a thermal printer. Obtained and entered weighing data can be printed.

**The Print Out**

In the printout, a gross weight is indicated with the letters "B/G" and a net weight with the letter "N". A manually entered tare weight is also printed and is indicated with the letters "PT". The total weight is shown with the letters "TOT".

Standard print-out without code		Standard print-out with code	
B/G	1234.5 lb. (560 kg)	CODE	12345
T	34.5 lb. (15.6 kg)	B/G	1234.5 lb. (560 kg)
N	1200.0 lb. (544.3 kg)	T	34.5 lb. (15.6 kg)
Nr.	1	N	1200.0 lb. (544.3 kg)
10/07/03	17:45	Nr.	1
		10/07/03	17:45
Piece count print-out without code		Piece count print-out with code	
B/G	1234.5 lb. (560 kg)	CODE	12345
T	34.5 lb. (15.6 kg)	B/G	1234.5 lb. (560 kg)
N	1200.0 lb. (544.3 kg)	T	34.5 lb. (15.6 kg)
PcWt	1.234 lb. (0.5 kg)	N	1200.0 lb. (544.3 kg)
Qty	12345 PCs	PcWt	1.234 lb. (0.5 kg)
Nr.	1	Qty	12345 PCs
10/07/03	17:45	Nr.	1
		10/07/03	17:45
Total print-out (always without code)			
Tot. B/G	1234.5 lb. (560 kg)		
Tot. T	34.5 lb. (15.6 kg)		
Tot. N	1200.0 lb. (544.3 kg)		
Tot. Nr.	999		
10/07/03	17:45		

## Changing the Thermal Paper Roll

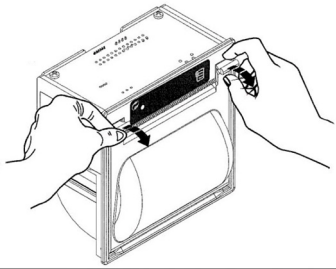
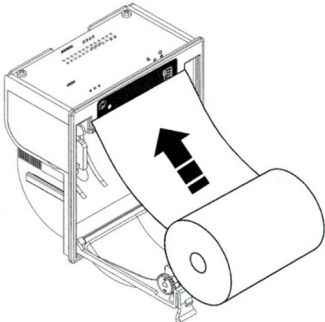
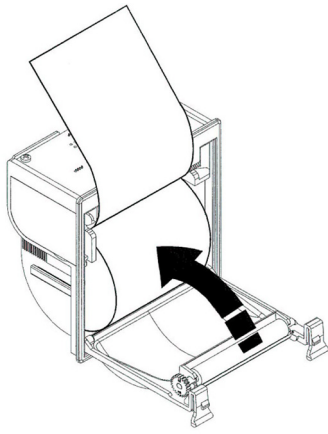
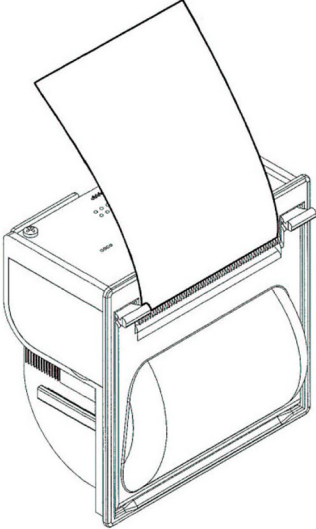



	
<p>1. Press down the two levers and pull the cover towards you to open the printer cover.</p>	<p>2. Remove the existing paper roll. Position the new paper roll, making sure it unrolls in the correct direction, as shown above.</p>
	
<p>3. Unroll the paper slightly. Re-close the cover, holding the edge of the paper.</p>	<p>4. The printer is now ready for use.</p>

**Changing the Time and Date on the Print-out**

The date and time can be printed together with the weight information.

- Press the  key for 6 seconds.
  - The display shows "ho\_00" or the previous hour time setting with the right digit flashing.
- Press ENTER (↵) to accept the old value.

**Or**

- Press the  key to go up a value or press the  key to go down a value until the required value is reached.
- Press < to change to the next digit and use the  or  key to change the value until the required value is reached.
- Press ENTER (↵) to accept the new value.
  - The display shows "m\_00" or the previous minute time setting with the right digit flashing.
- Repeat the above procedure to accept or change the minute setting.
  - The display shows "dA\_00" or the previous date of the month setting with the right digit flashing.
- Repeat the above procedure to accept or change the date of the month setting.
  - The display shows "m\_00" or the previous month setting with the right digit flashing.
- Repeat the above procedure to accept or change the month setting.
  - The display shows "YE\_00" or the previous year setting with the right digit flashing.
- Repeat the above procedure to accept or change the year setting.
- The indicator returns to normal weighing mode.

## TROUBLESHOOTING

Use the troubleshooting procedures shown in the following table as a guide only.

CONDITION	SUB-CONDITION	POSSIBLE CAUSE	ACTION
No lifting	Pump does not lift the load.	An air lock in the hydraulic system.	Pull up on the fingertip control and hold while pumping the handle 8 to 10 times to bleed air from the system.
	Lifting, neutral, and lowering do not function properly.	Chain anchor is out of adjustment.	Turn the nut on the chain anchor clockwise until the pumping action, while in neutral, does not raise the forks.
	Forks raise and sink with pump action.	Dirt or foreign particle is caught in the cone valve seat.	Pull up on the fingertip control and hold while pumping the handle 8 to 10 times to purge the valve system.
Indicator is not responsive	Blank screen.	Empty or defective battery	Use a fully charged battery pack. (See "The Battery" on page 6.)
	Component damage.	Short or humidity.	Measure 12VDC across the battery terminals. If the multimeter reads 12VDC, replace the board.

CONDITION	SUB-CONDITION	POSSIBLE CAUSE	ACTION
Accuracy problem	Scale gives different readings for the same load.	Mechanical problem.	<p>Load left and right fork with, for example, body weight and see if the weight changes when you are in different positions on the scale. There should not be a difference larger than 2 lb. (0.9 kg). If there is a bigger difference than 5 lb. (2.3 kg), you have a load cell or a mechanical problem.</p>
			<p>To make sure it is a mechanical problem, repeat the test with a heavy load on the scale. Lift a pallet with 2000 or 3000 lbs. (907 to 1361 kg). Reset the indicator for 0 lb. using the tare function. Load corners with body weight by standing on, or on the sides of the pallet. If the readings change more than 5 lb. (2.3 kg) you have a mechanical problem.</p>
			<p>With the forks lifted half way up, the brackets for the loading wheels may touch the fork shoe. By taking off the fork shoe, scratches show if and where it touches. Check if the cover bolts are loose and tighten as required.</p>
		Load cell problem.	<p>To be sure that it is not a mechanical problem, load the load cells directly. Take off the fork cover. Try to apply weight 55 to 110 lbs. (25 to 50 kg) direct onto each load cell. If the indicator shows the same reading, the load cells are OK.</p>
			<p>Measure the resistance with an ohm meter between the wires and load cell body. Do this with the other load cells disconnected from the indicator. The load cells should measure approximately 350 ohms between the signal wires: yellow and green, and excitation wires, black and red.</p>

<b>CONDITION</b>	<b>SUB-CONDITION</b>	<b>POSSIBLE CAUSE</b>	<b>ACTION</b>
Accuracy problem  cont'd	Scale gives different readings for the same load.	Cable problem.	Bad connections cause changes when moving the scale.  Bend and move the cable briskly, especially where the cable is moving continuously while lifting. While doing so, look at the display to see if it reacts to the movements.
		Potentiometer problem.	Move the board and put pressure with fingers on the potentiometers. If you see no change on the screen, the potentiometer is good. If you see changes on the screen, the potentiometer is bad and needs to be replaced. Do not touch the contact.



CONDITION	SUB-CONDITION	POSSIBLE CAUSE	ACTION
Reading instability	The screen fluctuates between different values and never settles to the actual value	Humidity	Check for water marks on the indicator board or load cell connections (potentiometers).
		Indicator	Sometimes the indicator shows a weight when the load cells are disconnected. If you do this and the indicator becomes more stable, it is most likely elsewhere in the system.
			Check visually for traces of oxidation. If found, heating the solder contacts can solve the problem.
		Cables	<p>Bad connections cause changes when moving the scale.</p> <p>Bend and move the cable briskly especially where the cable is moving continuously when lifting. While doing so, look at the display to see if it reacts to the movements.</p>
		The potentiometers with which we calibrate the output of the load cells are mechanical parts and are sensitive to humidity, shocks, and vibration.	Move the board and put pressure with fingers on the potentiometers while looking at the display to see if it reacts. Do not touch the contact.
Load cells.	If connected independently to the indicator, it can be checked which one is unstable and which one is not.		

<b>CONDITION</b>	<b>SUB-CONDITION</b>	<b>POSSIBLE CAUSE</b>	<b>ACTION</b>
Function error	No reaction when pushing keys	Defective touch panel.	<p>Test can be done by making short cut on connection of the touch panel to simulate a key being pressed. Check for wear or broken contacts in the flat cable going to the indicator board.</p> <p>Take out the battery pack and replace to see if it starts up afterwards.</p>
	Not summing	Operator error.	<p>Make sure load is stable.</p> <p>Scale needs to be unloaded before accepting new print.</p> <p>System does not print weights that are smaller than the graduation. For example: Increments of 2 lb. (0.91 kg) graduation or 5 lb. (2.26kg) graduation.</p>
HELP messages	HELP 2	Scale is overloaded.	Take load from scale. If there is no load, do the same checks as you do with HELP 3 and 7.
	Help 3 or 7	Load cell signal too high or too low.	Check cables for damage. Move the cable while looking at the display to see if the indicator reacts.
			Measure the resistance with an ohm meter between the wires and load cell body. Do this with the other load cells disconnected from the indicator. The load cells should measure approximately 350 ohms between the signal wires: yellow and green, and excitation wires, black and red.
			Check the excitation signal of the indicator.
Help 4	Out of zero range.	Zero calibration needed.	

**THIS PAGE LEFT BLANK INTENTIONALLY**

# SPARE PARTS EXPLODED VIEW

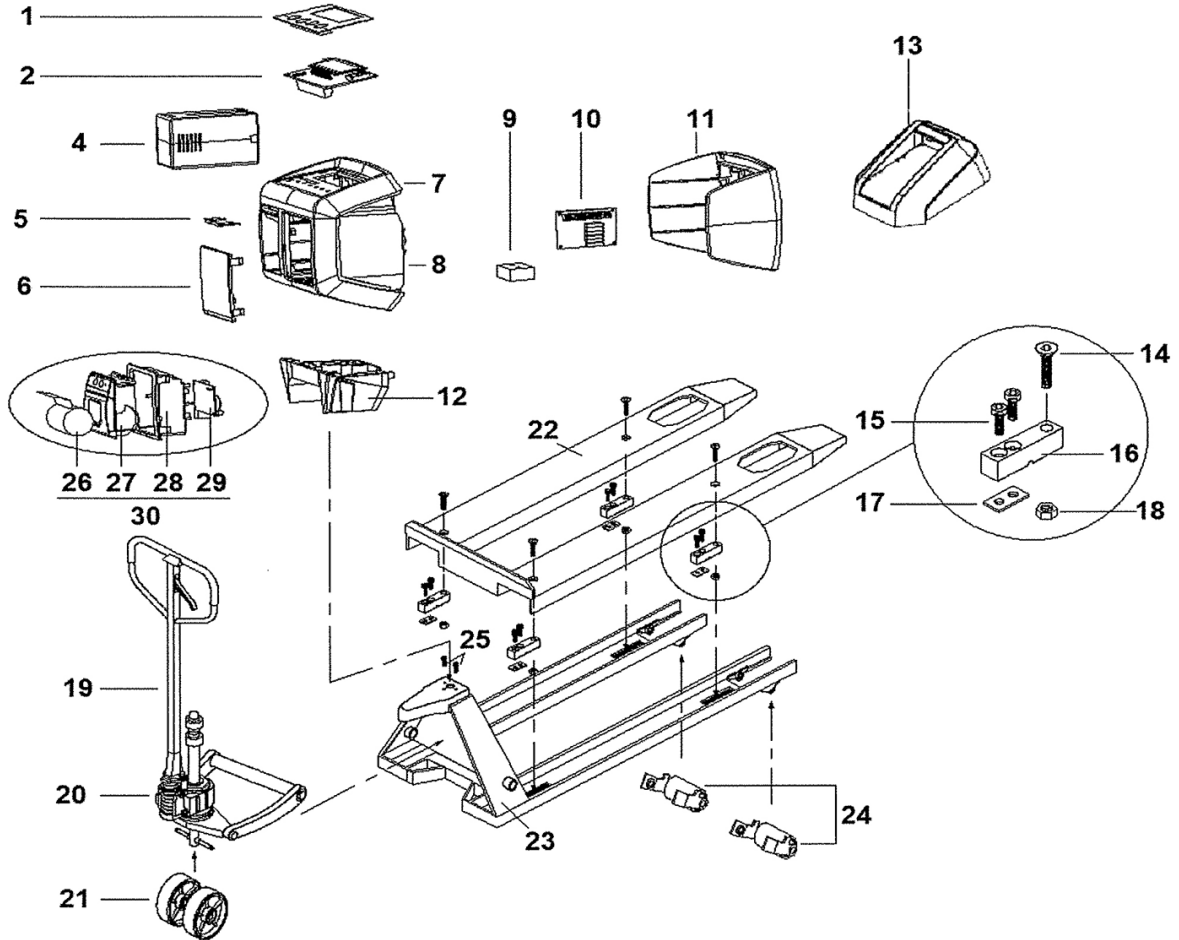

**SPARE PARTS LIST – Weighing Hand Pallet Truck Model LFTSC**

<b>No</b>	<b>Part Number</b>	<b>Description</b>	<b>Quantity</b>
1	990-1186	Panel, Touch Indicator	1
2	990-1187	Indicator, Print Board	1
4	990-1188	Battery Module 12 V 1.2 Ah with Handle	1
5	990-1189	Battery Module Fixation Clip	1
6	990-1190	Cover Plate Printer	1
7	990-1191	Indicator Housing, Top Cover	1
8	990-1192	Indicator Housing, Main Housing, RAL 5002	1
9	990-1170	Switch, Level	1
10	990-1193	Load Cell Calibration Board	1
11	990-1194	Indicator Housing, Back Cover, RAL 1028	1
12	990-1195	Indicator Housing, Pedestal	1
13	990-1196	Battery Charger	1
14	990-1155	Bolt, Forkshoe Mounting M12 x 60	1
15	990-1154	Bolt, Load Cell Mounting M12 x 35	2
16	990-1152	Load Cell	1
17	990-1153	Plate, Load Cell Mounting 6 MM	1
18	990-1156	Nut, Forkshoe Mounting	1
19	990-1157	Handle (Black)	1
20	990-1158	Pump (Black)	1
21	990-1160	Wheel, Steering Polyurethane	2
22	990-1150	Forkshoes, Set	1
23	990-1151	Chassis	1
24	990-1161	Wheel, Load (Polyurethane)	2
25	990-1162	Bolt, Indicator Support Mounting	2
26	990-1197	Paper, Single	1
27	990-1198	Printer, APS Thermal	1
28	990-1199	Printer, Mounting Part	1
29	990-1200	Voltage Regulator	1
30	990-1201	Printer Complete	1

---

## CALIBRATION

---

### Calibration Instructions Indicator

The calibration mode can only be accessed from the standard weighing mode. You cannot get into the calibration mode when you are in piece count mode.

### Defining Zero

- Unload the system.
- Switch the system on.
- To enter the zero calibration mode, press the >0< key for 10 seconds.
  - After 3 seconds, the display shows the last entered code.
  - After 7 seconds, the display goes into the zero calibration mode and starts adjusting.
  - The display shows "Adj08" and run down until "Adj00". The adjustment was completed.
  - The indicator shows the percentage of the total capacity that was adjusted. For a normal scale, this would be between 5 and 8 percent. A larger percentage could mean one or more load cells are broken. A lower percentage could mean the fork cover is not mounted.
  - When the zero point is defined, the system automatically returns to the standard weighing mode.

### Single Point Calibration

- Press the ⇔T key for about 10 seconds.
  - After 3 seconds, the display shows the last entered pre-set tare value.
  - After 7 seconds, the display goes into calibration mode.
  - The display shows the first calibration point with the pointer "e1" flashing.
- Use the ^ and v keys to see the three earlier programmed values on the display.
  - The pointer moves through e1-3. "e1" is the first calibration point, "e2" the second, and "e3" the third.

#### **When calibrating only one point, the second and third values should be set to zero.**

- Use the ^ and v keys to move to the second calibration point.
  - The display shows the pointer "e2" flashing.
- Press the ← key.
  - The display shows the previously entered calibration value, with the last segment flashing.
- Use the ^, v, and < keys to return all the segments to zero.
- Press the ← key.
- Use the ^ and v keys to move to the third calibration point.
- Repeat the above to set all the segments to zero.
- Press the ← key.

**Calibrating the single point**

- Use the  $\wedge$  and  $\vee$  keys to return to the first point.
  - The indicator shows the value of the first calibration point, with the “e1” pointer flashing.
- Load the scale with a known weight.
- Press the  $\leftarrow$  key to enter this weight onto the indicator. The first segment starts flashing.
- Use the  $\wedge$  and  $\vee$  keys to change all the segments until the proper weight is entered.
- Press the  $\leftarrow$  key to return to calibration mode. The “e1” pointer starts flashing.
- Press the  $\leftarrow$  key for 3 seconds to confirm the entered weight.
  - This calibration number counts down from “Adj 08” to “Adj 00”. The first calibration point is now set.
- Leave the calibration mode by pressing the  $\wedge$  or  $\vee$  key until “AP XX” is shown. This number indicates the calibration sensitivity percentage, for example, “AP 0”.
- Press the  $\leftarrow$  key.
  - The display shows the value of the gravitation constant. Use the  $\wedge$ ,  $\vee$ , and  $<$  keys to correct this for your location.
- Press the  $\leftarrow$  key to return to the standard weighing mode.

## Multi-Point Calibration

- Push the  $\leftrightarrow$ T key for about 10 seconds.
  - After 3 seconds, the display shows the last entered pre-set tare value.
  - After 7 seconds, the display goes into the calibration mode.
  - The display shows the first calibration point with the pointer "e1" flashing.
- Use the  $\wedge$  and  $\vee$  keys to see the three earlier programmed values on the display. The pointer moves through e1-3. "e1" is the first calibration point, "e2" the second, and "e3" the third.
- Use the  $\wedge$  and  $\vee$  keys to return to the first point.
  - The indicator shows the value of the first calibration point with the "e1" pointer flashing.
- Load the weighing system with a known weight.
- Press the  $\leftarrow$  key to enter this weight onto the indicator.
  - The first segment starts flashing.
- Use the  $\wedge$ ,  $\vee$ , and  $<$  keys to change all segments until the proper weight is entered.
- Press the  $\leftarrow$  key to return to calibration mode.
  - The "e1" pointer starts flashing.
- Press the  $\leftarrow$  key for 3 seconds to confirm the entered weight.
  - This calibration number counts down from "Adj 08" to "Adj", the first calibration point is now set.
- Move to the second calibration point.
  - The display shows the pointer "e2" flashing.
- Repeat the procedure for a second known weight. Be aware that the value of this weight has to be higher than that of the first weight. If not, the display shows "ERR98" and returns to the entry mode for the calibration point.
- Repeat the procedure for the third known weight. Leave calibration mode by pressing the  $\wedge$  or  $\vee$  key until "AP XX" is shown.
  - This number indicates the calibration sensitivity percentage, for example, "AP 07".
- Press the  $\leftarrow$  key.
  - The display shows the value of the gravitation constant. Use the  $\wedge$ ,  $\vee$ , and  $<$  keys to correct this for your location.
- Press the  $\leftarrow$  key to return to the standard weighing mode.



---

## PARAMETER SETTINGS

---



**ATTENTION:** Before entering the setup mode, make sure that the battery supply is sufficient. A low battery may cause the micro-processor to block. If this happens remove the empty battery and replace it with a fully charged battery. You should be able to start the indicator in the normal way.

To enter the setup mode, turn on the indicator and keep the  $\text{\textcircled{1}}$  key pressed for 20 seconds. You go through the normal start-up routine (all segments on; software version; calibration number, and weight) and end up in the "P\_01" with the right digit flashing.

At this stage you may proceed as follows:

- Press the  $\leftarrow$  key quickly to enter parameter 01.
  - The display shows the setting for this parameter at this moment.
- You may change the setting by using the  $\wedge$  or the  $\vee$  key.

**OR**

- You can accept the setting by pressing  $\leftarrow$ .

**OR**

- To move to the next parameter you press the  $\wedge$  key.

**OR**

- To move to the previous parameter you press the  $\vee$  key.

To leave the set-up mode, you do the following:

- With "P\_XX" in the display, press the  $\text{\textcircled{1}}$  key quickly.
  - The display shows "P\_00".
- Press the  $\text{\textcircled{1}}$  key again quickly.
  - If a change was made to the settings, the display shows "SET\_" briefly and then returns to the normal weighing mode. The calibration number is increased every time a change is made in the set up and also after a new calibration.
  - If no change was made, the display returns into the normal weighing mode.

In the following pages, the different parameters are explained and the standard settings are given. Parameters that are not used yet are not accessible or shown with underscores.

**PARAMETERS:**

<b>Parameter</b>	<b>Function</b>	<b>Settings</b>	<b>Default US</b>
01	Start-up unit (and print units)	1=kg / 2=lb.	2
02	Smallest graduation step for multi-range	0.1/0.2/0.5.....10/20/50	0.5
03	Largest graduation step for multi-range	0.1/0.2/0.5 .....10/20/50	2
04	Number of graduations for every range	0000-9900 divisions	1000
05	Weighing capacity system (full scale)	0000-99999 units	5000
06	Motion tolerance for stable	0-32	1
		off                      0.5 grad./sec	
		1 grad./sec            2 grad./sec	
		4 grad./sec            8 grad./sec	
		16 grad./sec          32 grad./sec	
07	Filter size	0-12	8
		0=off	
		1=light filtering, 12=heavy filtering	
08	Auto zero range	0=off                      0.5 division	0.5
		1=division                3 divisions	
09	Zero range positive (+)	0-100% (approved 2%) of span	10
10	Zero range negative (-)	0-100% (approved 2%) of span	10
11	Test Function	BASIC                    ADC Counts	BASIC
		10x Resolution	
12	Not used		
13	Not used		
14	Start-up number to add in sampling mode	1-2-5-10-20-50-95	10
15	Units switch mode active	Yes / No	Yes

<b>Parameter</b>	<b>Function</b>	<b>Settings</b>	<b>Default US</b>
16	Setpoint function	0-4	0
		0=not used	
		1=overload gross (only 1 setpoint used)	
		2=overload gross (only 1 setpoint used)	
		3=Printer (without date/time/switched supply)	
		4=not used	
17	Application	Basic (standard) or Peakhold (Phold)	BASIC
18	Gravity value working area	9.750-9.850	9.797
19	Key function	Remote - Local - Both	Local
20	Baudrate comport 1	600-1200-2400-4800-9600-19200	9600
21	Databits comport 1	7-8	8
22	Parity comport 1	none/odd/even	none
23	Stopbits comport 1	1-2	1
24	Not used		
25	Dataprotocol comport 1	0-4	0
		0=PC bi-directional command structure	
		1=not used	
		2=Remote display continuously	
		3=Printer (without date/time/switched supply)	
		4=not used	
26	Number of linefeeds comport 1	0-9	0
27-29	Not used		
30	Baudrate comport 2	600-1200-2400-4800-9600-19200	9600
31	Databits comport 2	7-8	8
32	Parity comport 2	none/odd/even	none
33	Stopbits comport 2	1-2	1
34	Not used		
35	Dataprotocol comport 2	0-4	3
		0=PC bi-directional command structure	
		1=not used	
		2=Remote display continuously	
		3=Printer (without date/time/switched supply)	
		4=not used	

<b>Parameter</b>	<b>Function</b>	<b>Settings</b>	<b>Default US</b>
36	Number of linefeeds comport 2	0-9	5
37	Printout form	0-1	0
		0=standard 1=total	
38	Printout format time/date	European format dd/mm/yy hh:mm	USA
		USA format mm/dd/yy hh:mm	
39	Not used		
40	Level switch	0=not used 1=N.C. 2=N.O.	0
41	Delay trigger time level switch	0-10 sec.	3
42	Not used		
43-49	Not used		
50	Battery used	12VDC 6 VDC	12v
51	Low Bat switch off time	0-99 mins	2
		0=not switched off	
52	Auto shut off time if not used	0-99 mins	15
		0= always on	
53	Not used		
54	Peak hold time	0-7	4
55	threshold value	9999kg/lb	200
56-89	Not used		
90	Reset to default parameter setting without altering calibration parameters	If parameter 01 was on 1, it defaults to the EU settings. If P_01 =2, the US setting is defaulted. New delivered boards have EU settings.	
91	Reset to default parameter settings including calibration parameters	If parameter 01 was on 1, it defaults to the EU settings. If P_01 =2, the US setting is defaulted. New delivered boards have EU settings.	
92-99	Not used		

---

**LIFT-RITE® LEGAL FOR TRADE SCALE TRUCK (LFTSC)  
WARRANTY CERTIFICATE**

---

Your new *Lift -Rite* LFTSC is warranted against defects in materials and workmanship as follows:

**One (1) Year** parts only warranty from date of delivery on all Non-wearable parts.

**Six (6) Months** parts only warranty from date of delivery on all Wearable parts.

- Wheels and tires
- Bearings
- Fuses
- Batteries

Components found to be defective by the product manufacturer or an authorized *LIFT-RITE* Dealer will be replaced or repaired. Replaced or repaired components will be warranted for the balance of the applicable truck warranty period, or 30 days, whichever is longer. Freight charges incurred for parts involved in the replacement or repair of a defective component will be covered up to \$120 (US). Labor charges may be reimbursed up to \$60 (US) per unit, per repair, at the sole discretion of the manufacturer. Transportation of the product to and from a *LIFT-RITE* authorized dealer, local taxes, and customs charges, if any, are excluded.

This warranty does not apply to the following:

Any attachments purchased for use with this truck.

LIFT-RITE reserves the right to make changes and improvements in design without making changes to previously manufactured products of the same description.

Notwithstanding any other language contained herein, this warranty is expressly voided without any further notice if any modification is made to the *LIFT-RITE* product, or if additional components or devices are added to the *LIFT-RITE* product, without prior approval having been granted in writing by *LIFT-RITE*.

**THIS WARRANTY IS IN LIEU OF ALL OTHER WARRANTIES, EXPRESSED, IMPLIED, OR STATUTORY. THERE ARE NO WARRANTIES OF MERCHANTABILITY OR FITNESS FOR A PARTICULAR PURPOSE. In no event shall LIFT-RITE be liable for incidental, special, or consequential damages.**

---

## SELECTED OSHA REGULATIONS FOR LIFT TRUCKS

---

*Note: Some or all of the following may not be applicable to your hand pallet lift truck.*

The use of forklift trucks in the workplace is governed by various regulations. In the United States, the Federal Occupational Safety and Health Administration (OSHA) has issued regulations which cover the majority of workplaces.

In addition, several states have implemented regulations which apply instead of the Federal regulations.

Check with your local OSHA office or provincial Labor Bureau to confirm which regulations govern your workplace.

Because of their wide applicability, this section of your manual lists several parts of the Federal OSHA regulations that might be of particular importance to your workplace.

The full text of the Federal regulations can be found in the Code of Federal Regulations at 29 CFR Section 1910.178.

The following citations are followed by a reference to the appropriate subparagraph of the regulations.

- Modifications and additions which affect capacity and safe operation shall not be performed by the customer or user without manufacturers prior written approval. Capacity, operation and maintenance instruction plates, tags or decals shall be changed accordingly. (a) (3)
- The user shall see that all nameplates and markings are in place and are maintained in a legible condition. (a) (6)
- The employer shall ensure that each powered industrial truck operator is competent to operate a powered industrial truck safely, as demonstrated by the successful completion of the training and evaluation specified in this paragraph. (l) (1) (i)
- Prior to permitting an employee to operate a powered industrial truck (except for training purposes), the employer shall ensure that each operator has successfully completed the training required by this paragraph. (l) (1) (ii)
- Trainees may operate a powered industrial truck only under the direct supervision of persons who have the knowledge, training, and experience to train operators and evaluate their competence and where such operation does not endanger the trainee or other employees. (l) (2) (i) (A) (B)
- Training shall consist of a combination of formal instruction (e.g. lecture, discussion, interactive computer learning, videotape, written material), practical training (demonstrations performed by the trainer and practical exercises performed by the trainee), and evaluation of the operator's performance in the workplace. (l) (2) (B) (ii) [Editorial Note: For required training program content, refer to (l) (3) (i) (A-M) and (l) (3) (ii) (A-I).]
- Refresher training, including an evaluation of the effectiveness of that training, shall be conducted as required by paragraph (l) (4) (ii) to ensure that the operator has the knowledge and skills needed to operate the powered industrial truck safely. (l) (4) (i)
- An evaluation of each powered industrial truck operator's performance shall be conducted at least once every three years. (l) (4) (iii)
- The employer shall certify that each operator has been trained and evaluated as required by this paragraph (l). The certification shall include the name of the operator, the date of the training, the date of the evaluation, and the identity of the person(s) performing the training or evaluation. (l) (6)
- The employer shall prohibit arms or legs from being placed between the uprights of the mast or outside the running lines of the truck. (m) (4)
- Brakes shall be set and wheel blocks shall be in place to prevent movement of trucks, trailers or railroad cars while loading or unloading. Fixed jacks may be necessary to support a semitrailer when the trailer is not coupled to a tractor. The flooring of trucks, trailers, and railroad cars shall be checked for breaks and weakness before they are driven onto. (m) (7)
- Only approved industrial trucks shall be used in hazardous locations. (m) (11)

- All traffic regulations shall be observed, including authorized plant speed limits. A safe distance shall be maintained approximately three truck lengths from the truck ahead, and the truck shall be kept under control at all times. (n) (1)
- The driver shall be required to slow down and sound the horn at cross aisles and other locations where vision is obstructed. If the load being carried obstructs forward view, the driver shall be required to travel with the load trailing. (n) (4)
- Under all travel conditions the truck shall be operated at a speed that permits it to be brought to a stop in a safe manner. (n) (8)
- Stunt driving and horseplay shall not be permitted. (n) (9)
- If at any time a powered industrial truck is found to be in need of repair, defective, or in any way unsafe, the truck shall be taken out of service until it has been restored to safe operating condition. (p) (1)
- Any power-operated industrial truck not in safe operating condition shall be removed from service. All repairs shall be made by authorized personnel. (q) (1)
- All parts of any such industrial truck requiring replacement shall be replaced only by parts equivalent as to safety with those used in the original design. (q) (5)
- Industrial trucks shall be examined before being placed in service, and shall not be placed in service if the examination shows any condition adversely affecting the safety of the truck. Such examination shall be made at least daily. Where powered industrial trucks are used on a round-the-clock basis, they shall be examined after each shift. Defects when found shall be immediately reported and corrected. (q) (7)

**Part Kit Number**

1234962

**LIFTRITE®**